

## FCST012230 Fiber Optic Splice Closure



### Product Overview

FCST012230 Fiber Optic Splice Closure specially designed to provide reliable and long-lasting protection for optical fibers and splices, combined with maximum ease of installation and maintenance. The closure is made of glass-filled polypropylene, which can make sure long time service. Heat shrink seal for cable ports, excellent sealing performance.

### Product Advantages

- Cable diameter: 1 Uncut port meet  $\phi 10 \sim 15\text{mm}$  cable; 6 branch ports meet  $\phi 8 \sim 15\text{mm}$  cable
- Product capacity: Single fiber max capacity is up to 144f, also support max 432f ribbon fiber
- Installation method: Suitable for direct buried, aerial, pole, pipeline, manhole, etc.
- Sealing mode: heat shrink seal is adopted for cable ports, with protection grade of IP68.
- Easy installation with no special tool required.

### Product Specifications

Construction	Description
<b>Max. Capacity</b>	Single fiber:144 cores Ribbon fiber:432 cores
<b>Material</b>	PP+GF

<b>Dimension (mm)</b>	525*Φ225
<b>Inlets/Outlets</b>	1 Uncut port,6 Branch ports
<b>Installation</b>	Aerial, wall, pole, manhole, pedestal etc.
<b>Net Weight (g)</b>	3.6-4.2
<b>Protection Level</b>	IP68
<b>Diameter Of Fiber Cable</b>	Uncut port: Φ 10~ Φ 15mm Branch port: Φ 8~ Φ 15mm
<b>Sealing Mode</b>	Heat shrink seal
<b>Splice Tray Capacity</b>	Single fiber: 36cores Ribbon fiber:108 cores
<b>Max No.Tray Installed</b>	4pc



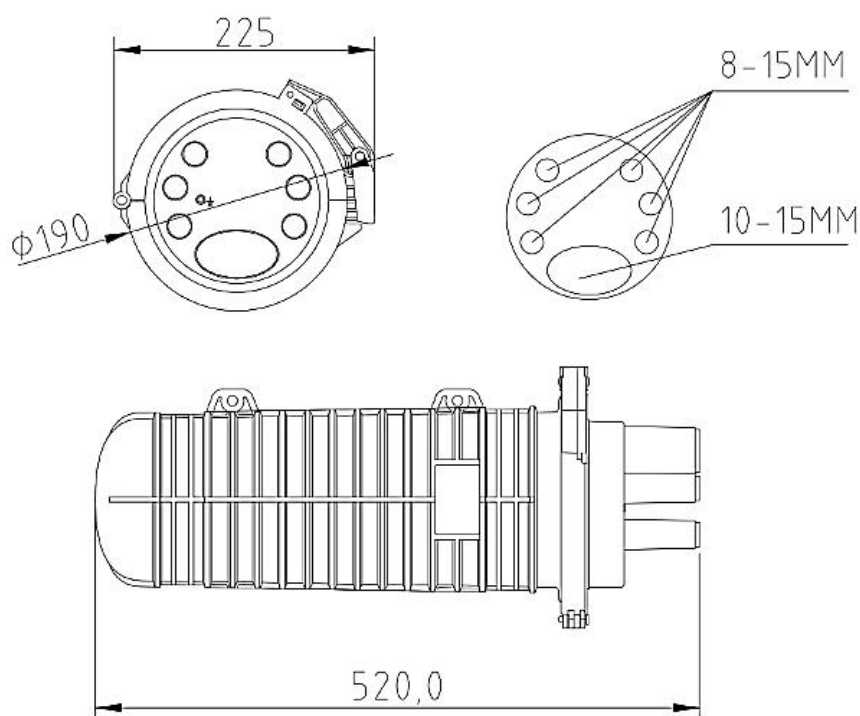

## Product Structure



### Standard accessories (Picture only for refer)

Item	Description	Qty	Picture
1	Heat shrink tube for uncut port	1 pc	
2	Heat shrink tube for branch port	1 pc	
3	Branch clip	1 pc	
4	Aluminum paper	7 pcs	
5	Insulation tap	1 roll	
6	Splicing protective tube	1 bag	
7	Nylon cable tie	1 bag	
8	Sand paper	1 pc	
9	Installation manual	1 set	
10	EVA tube	1 roll	
11	Clean paper	1 pc	
12	Silicon oil	1 pc	

### Optional Accessory

Item	Description	Qty	Picture
1	Air Valve	1set	
2	Ground lead	1 set	
3	Aerial mounting fittings	1 set	
4	Pole mounting fittings	1 set	
5	Wall mounting fittings	1set	

## Packing Information

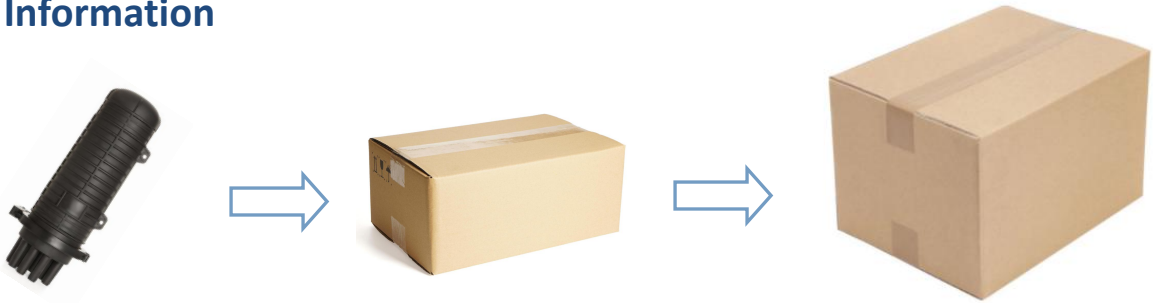

Construction	Description
Outside Dimension (L*M*H) mm	540*245*210
Weight/PC (kgs)	4.5
Carton size (L*W*H) mm	555*510*675
Qty/CTN (pcs)	6
Weight/CTN (kgs)	27.6

## Design And Customization Services

- Provide service with whole process form blueprint to product to the customer.
- Meet customer's requirement to customize logo in suitable place for existing product.
- Meet customer's requirement to make reasonable modify and customization for existing product.
- Provide free design according to the requirement of customer after signed cooperative agreement.



**FCST01131**

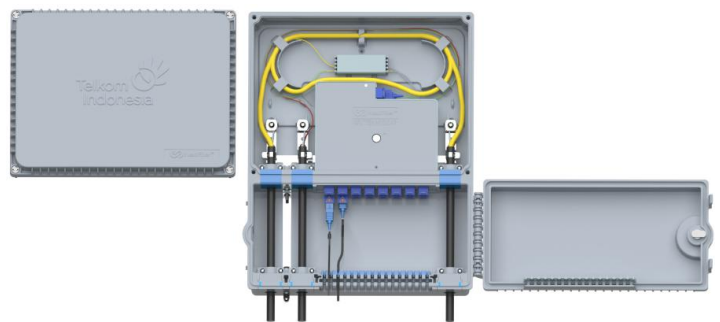

**FCST02253**